

feather&black

Perfect Bedtimes

Radley – WHITE 3 DRAWER CHEST

IMPORTANT READ CAREFULLY – RETAIN FOR FUTURE REFERENCE

Thank you for buying the Radley bedroom range.

- Please take a few quiet minutes to read these instructions

PRODUCT SAFETY







- All assembly fastenings should always be tightened properly and care should be taken that no fittings are loose
- Drawers are fitted with drawer stops to prevent them from being pulled out completely. The stops are attached to the inside back panel of the drawer box. To release part open the drawer and turn the wooden drawer stop whilst removing the drawer.
- Wall ties are included for the following items: Wardrobe, 3 and 5 Drawer Chests – please fit them according to the instructions

PRODUCT CARE

- Do not use abrasives or cleaning products which may contain ammonia or solvents
- Any spills should be removed immediately
- Wipe clean using a soft damp cloth followed by dry cloth
- Take care when handling or moving the furniture. Careless handling can damage wooden furniture, try to lift rather than drag.
- Colour may vary due to this being a natural product.

TOOLS REQUIRED

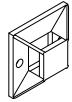

	PARTS	QTY
A	 Ø4x23 mm	6
B		6
C	 Ø4x35 mm	6
D		6
E	 Ø4x20 mm	4
F		2
G		4

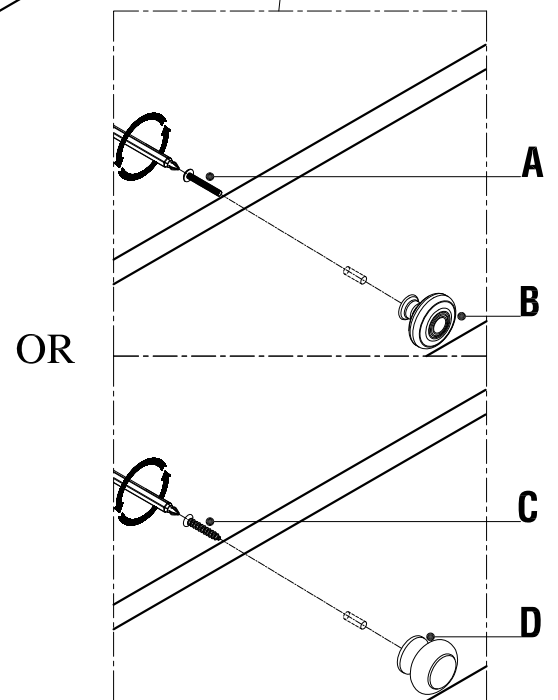
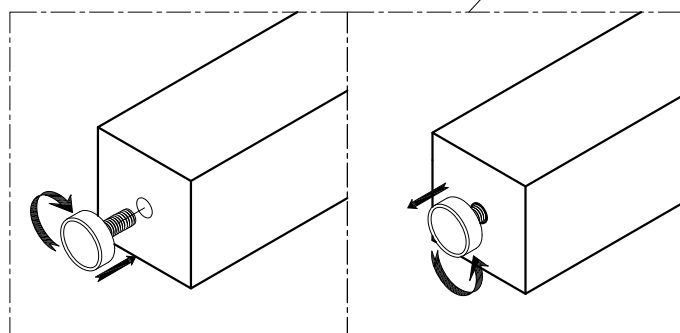
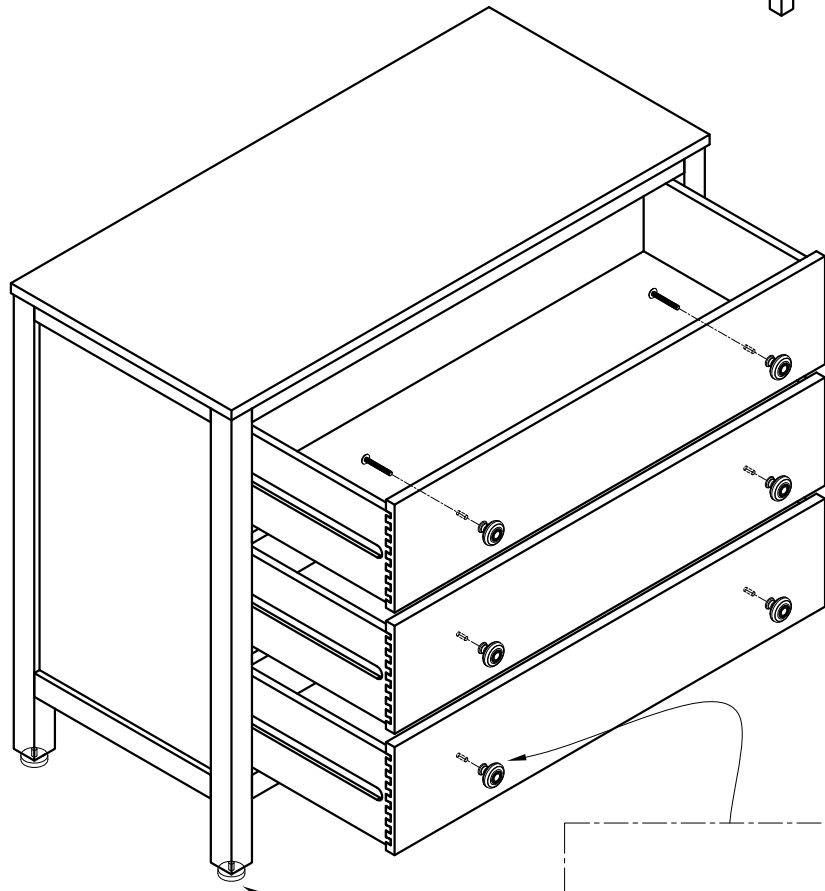
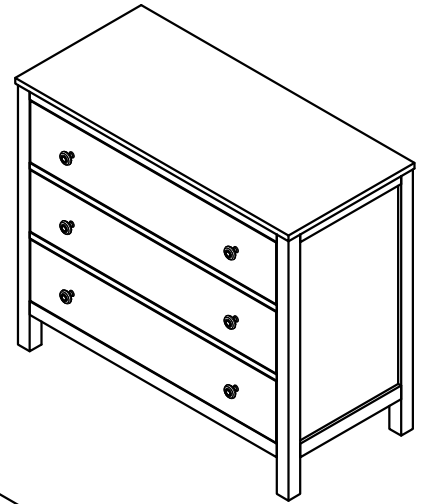

STEP 1

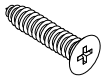
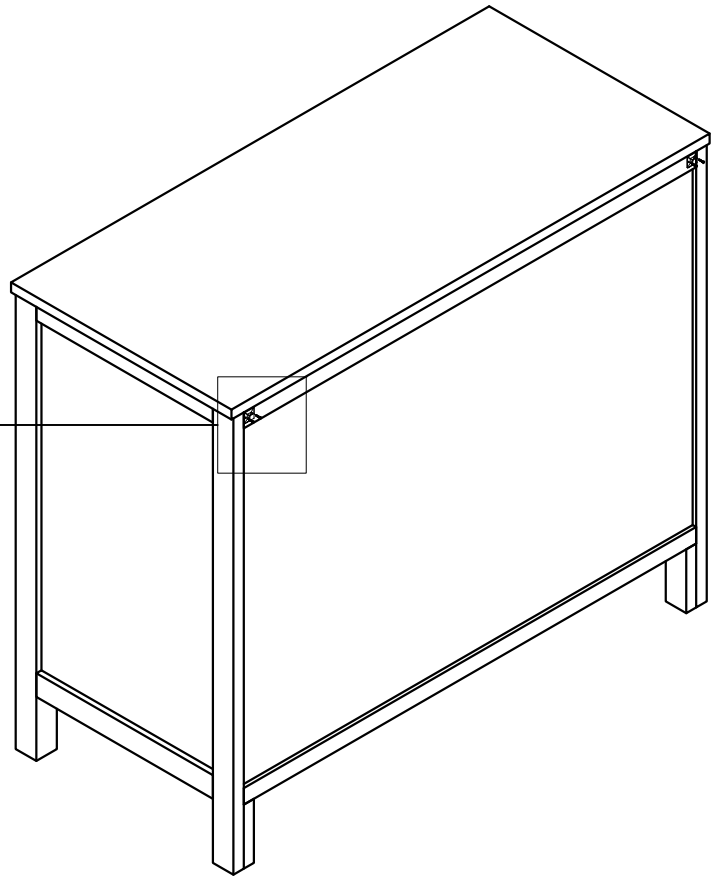
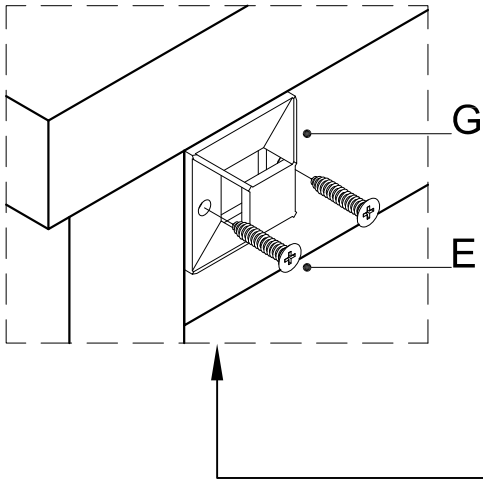

E X 4

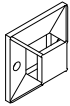

G X 2

STEP 2

NOTE: As all wall types vary.
Wall fixings are not included.
Please ensure suitable fixings
for your wall type. If in
doubt please contact a
qualified trade person.

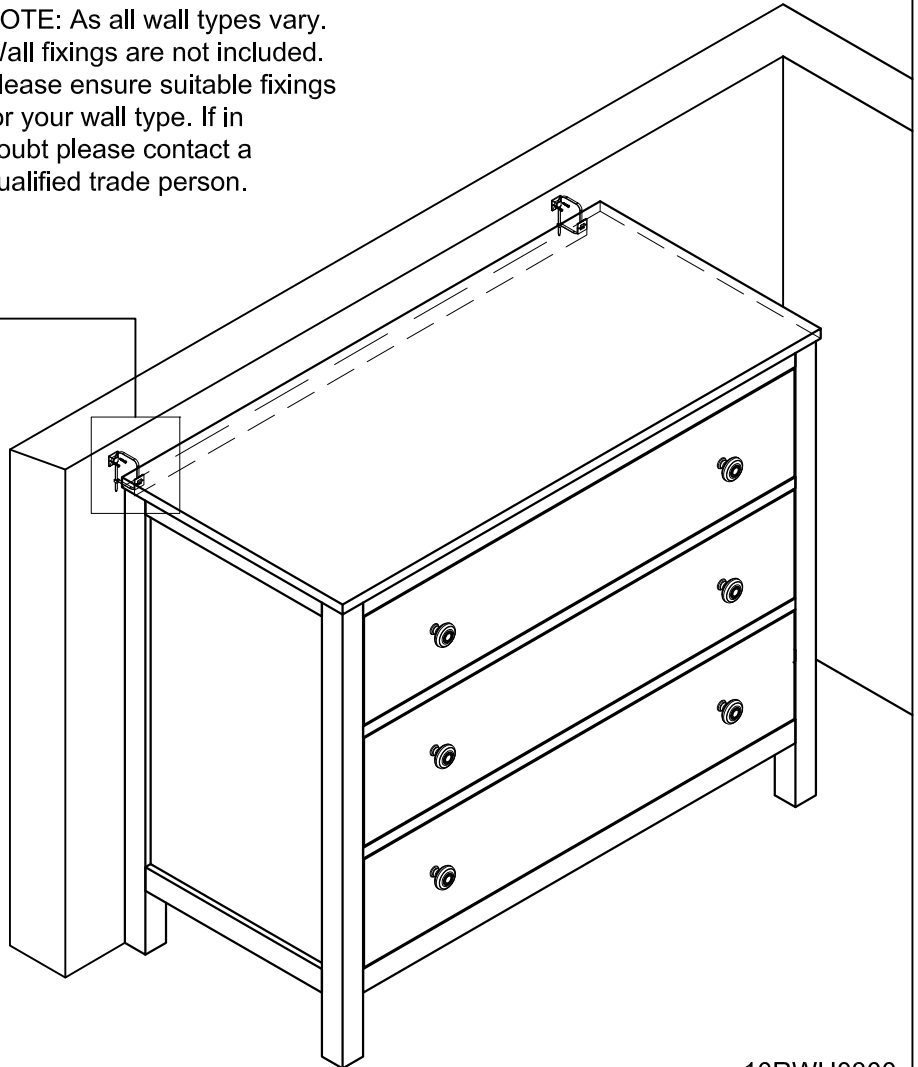
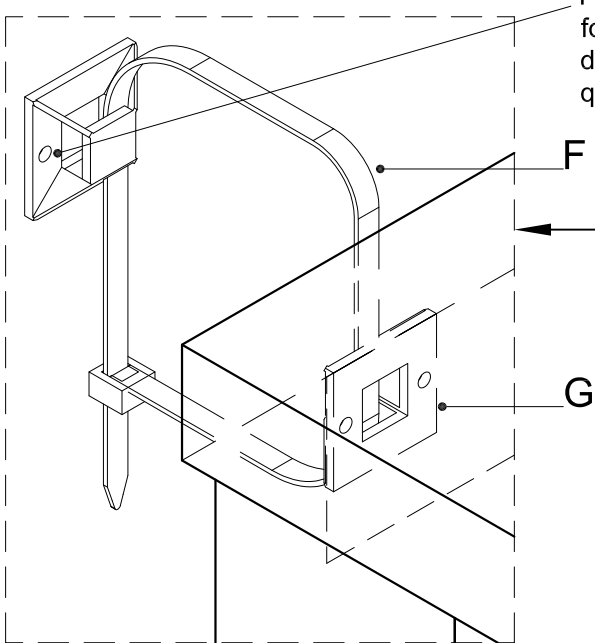

F X 2

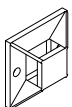

G X 2